



Installation instructions

Akrapovič Product:
Slip-On Race Line
for the
Porsche 911 GT3 (type 992)

ENGLISH
Version 1.0

04/2022



www.akrapovic.com

D249.1.00.0000 D



Installation instructions

Akrapovič Product:
Slip-On Race Line
for the
Porsche 911 GT3 (type 992)

ENGLISH
Version 1.0

04/2022

www.akrapovic.com

D249.1.00.0000 D

Congratulations on purchasing the Akrapovič product. The Akrapovič product is made by Akrapovič d.d., Malo Hudo 8a, 1295 Ivančna Gorica, Slovenia ("Akrapovič").

Please read this entire installation manual carefully prior to installing and using the Akrapovič product.

Akrapovič product should only be installed by persons skilled in car exhaust system or other car parts installation and performance. The instructions provided in this manual should be followed to ensure proper installation and safe use of the Akrapovič product. Akrapovič and/or its partners shall not be held liable for any damage or personal injury (including direct, indirect, or consequential damage) sustained as a result of improper installation of the Akrapovič product or its use and maintenance contrary to the instructions and warnings contained herein.

If you have any questions regarding the installation and/or proper use of the Akrapovič product or this manual, please contact your local Akrapovič partner.

For more information on the Akrapovič products, see the official Akrapovič website at: <http://www.akrapovic.com>

GENERAL INFORMATION

Your safety is our number one priority. Please drive your car responsibly, safely and always obey local traffic rules.

All statements made with regard to the product's compliance are made in respect of the product "as is". Any modifications of the Akrapovič product or its improper installation, use or maintenance that is not in accordance with this Installation manual, may result in severe damage to the product, vehicle and/ or engine, as well as personal injury, and may affect the product's compliance with the legal requirements, such as product's air and/ or noise emissions (as an example, the car may not be suitable for use on public roads any longer), as well as warranty coverage.

The product may only be used in accordance with relevant laws and regulations, including state and federal, where applicable.

Damage caused by improper installation, use and maintenance of the Akrapovič product is not covered by the Akrapovič warranty. Please refer to the enclosed warranty with regard to the terms of our warranty.

Technical specifications of Akrapovič products are subject to change without notice.

COPYRIGHT AND OTHER RIGHTS NOTICE

The Akrapovič trademark, including corporate logos and emblems, are subject to copyright as well as trademark rights of Akrapovič, its licensors, or third persons authorizing Akrapovič to use them.

Any reproduction, technical or other manipulation, translation, or other use of the copyright and/or trademark rights contained herein is prohibited without the explicit prior written consent of Akrapovič. The same especially applies to the entire contents of this manual and/or any of its parts, including but not limited to technical specifications, instructions, graphs, photographs, and so on included in this manual.

Akrapovič takes all copyright and other rights infringement cases under serious consideration. If you have any reason to believe that your product is not an original Akrapovič product, please contact our local partners or Akrapovič at info@akrapovic.com.

SAFETY AND COMPLIANCE WARNING, PLEASE READ CAREFULLY

BEFORE REMOVING THE STOCK PARTS AND BEGINNING THE INSTALLATION OF YOUR NEW AKRAPOVIČ PRODUCT, PLEASE MAKE SURE THAT ALL ITEMS LISTED BELOW ARE VERIFIED:

- This manual is specific to the car indicated on the cover page, for which it is designed. Installation procedures vary depending on the type of car. Please verify that the Akrapovič **product and this installation manual correspond to the type of your car.**
- **For exhaust system only:** the exhaust system can get extremely hot during and after it is used. Make sure not to touch the exhaust system until it is completely cool. **Allow the exhaust and engine to cool down before beginning installation.**
- Make sure the car is **securely positioned to prevent** damage to yourself and other, or the car.
- Please check the parts you received against the parts list available on our website (please use the QR code on the front page or look for “schematic view” in the respective product page on www.akrapovic.com). Make sure that you have **all the parts necessary for the installation** of your new Akrapovič product. If any of the parts is missing, please do not proceed with uninstalling your stock parts/installing the Akrapovič product and contact the retailer where you purchased the Akrapovič product.
- **For exhaust system only:** every exhaust system muffler has its unique serial number, which identifies the authenticity of the product. You can find the serial number on the muffler's sleeve. Please refer to the **picture 1**. Please verify that your exhaust system is an original Akrapovič product. If you have any doubts, please contact the reseller where you purchased the exhaust system or Akrapovič partners. This manual, any certificates and Akrapovič warranty apply to original products only.

GENERAL NOTE

Photographs and other illustrations in this manual are symbolic and are intended to help represent individual steps for proper installation and use, as well as for a general overview. The actual component parts of the Akrapovič product may not entirely correspond to the photographs and other illustrations.

Picture 1 - EXAMPLE OF SERIAL NUMBER POSITION:

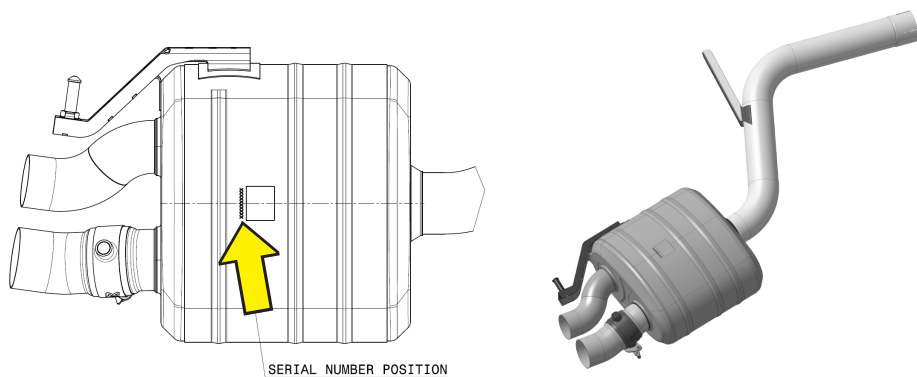

NOISE AND EMISSION WARNINGS

General warning

Because of the world-wide distribution of Akrapovič d.d. products, neither Akrapovič d.d. nor any of its subsidiaries make any representation that the products comply with the air and/or noise emissions laws, or labeling laws, of any jurisdiction. The purchasers are entirely responsible for informing themselves of the applicable laws where the products are to be used and to comply with those law.

Although legal compliance of Akrapovič products in a specific country should be determined by the user, you can find some basic guidance on compliance of your Akrapovič product with various legal requirements on the product-related part of our website (please use the QR code on the front page or look for the respective product page on www.akrapovic.com). For EC and ECE type approvals, please refer to the certificate enclosed to your product.

USA WARNING

Various U.S. states and the U.S. federal government have individual laws regulating the use of aftermarket parts and systems, especially as those parts and systems modify, remove, or replace original equipment catalysts. Please consult the appropriate laws in your area before installing any aftermarket part or system on your vehicle to ensure compliance with all applicable laws. Neither Akrapovic d.d. nor any of their subsidiaries or the sellers of the parts or systems make any representation that any of their parts or systems comply with any such laws.

CALIFORNIA WARNING

California laws prohibit the use of any aftermarket part or system that modifies, removes or replaces original equipment catalysts unless the California Air Resources Board has issued an Executive Order regarding such part or system or unless the part or system is exempted by being used only on racing vehicles on closed courses. Neither Akrapovic d.d. nor any of their subsidiaries make any representation that any of their parts or systems has received such an Executive Order or that any of their parts or systems conform with the racing vehicles exemption. The purchasers are entirely responsible for informing themselves of applicable California laws and to comply with those laws.

SYMBOLS

The following symbols are used throughout these installation instructions:



**TOOLS AND PROTECTIVE
EQUIPMENT REQUIRED**



TIGHTENING TORQUE



LUBRICATION



HAND TIGHTEN



INSTALLATION TIP



CAUTION OR IMPORTANT

USE BOLT SEALANT



Apply 3 to 4 small drops of bolt sealant onto the cleaned and degreased threads before tightening the bolts.

WARNING! Avoid contact with skin, eyes and mucous membranes. Do not inhale fumes. Keep out of reach of children.

USE ANTI-SEIZE LEAD-FREE COPPER PASTE (black tube)



Provides trouble-free and long-lasting protection against seizing, corrosion and rusting of bolts, threaded ends, nuts, joints, etc. Also protects against vibration, wear and impact. **WARNING! Avoid eye contact. Keep out of reach of children.**

USE ANTI-SEIZING GREASE (white tube)



Prevents seizing, corrosion and excessive wear between the titanium components. **WARNING! Avoid eye contact. Keep out of reach of children.**

Tools & equipment



- mechanic gloves
- eye protection
- Torx 25
- Torx 27
- Torx 30
- Torx E10
- Torx E12
- Socket 15 mm
- T-handle 8 mm wrench
- T-handle 10 mm wrench
- T-handle 13 mm wrench
- T-handle 13 mm swivelling wrench
- Ratchet 13 mm wrench
- Combination 13 mm wrench
- Combination 14 mm wrench
- Combination 17 mm wrench
- Combination 22 mm wrench
- Cutting nippers

PARTS LIST

The packaging box should contain one or more of the following items:

- Akrapovič product
- Homologation certificate/ compliance documents if applicable
- Warranty
- Fitting material
- Installation Manual

Detailed list of parts can be found on the Akrapovič website (please use the QR code on the front page or look for “Schematic view” in the respective product page on www.akrapovic.com).

IMPORTANT: The car should be in the off position throughout the dismantling and installation process, as well as any other work done on the Akrapovič product!

REMOVAL OF STOCK EXHAUST SYSTEM OR OTHER VEHICLE'S STOCK PARTS:

The process of uninstalling the original exhaust system or other parts may vary depending on the existing exhaust system or other vehicle parts. Please follow the original vehicle manufacturer's workshop manual for uninstalling the original exhaust system or other parts.

If you for any reason decide otherwise, please note that any information provided in this respect herein should be considered as general information provided for your convenience only. Akrapovič shall not assume any liability or responsibility with regard to uninstalling your existing exhaust system or other parts, warranty coverage of such exhaust system or other parts vehicle or their further fitness for use.

In case your Akrapovič exhaust system or other vehicle parts may not be used on certain roads or under certain conditions, please keep the stock (or other) exhaust system or other parts that you can use in such circumstances legally.

INSTALLATION OF THE AKRAPOVIČ DIFFUSER:

Put the vehicle onto a car lift.

! **CAUTION:** ensure that the car is lifted safely and properly in order to avoid the risk of vehicle damage, injury, or even death!

1. Unscrew and remove both rear wheels off the vehicle (F 01).

! **CAUTION:** make sure not to injure yourself or damage any part of the vehicle during this process!



F 01

2. Unscrew the marked bolts and remove the underengine panel (F 02).

! **CAUTION:** make sure not to injure yourself or damage any part of the vehicle during this process!

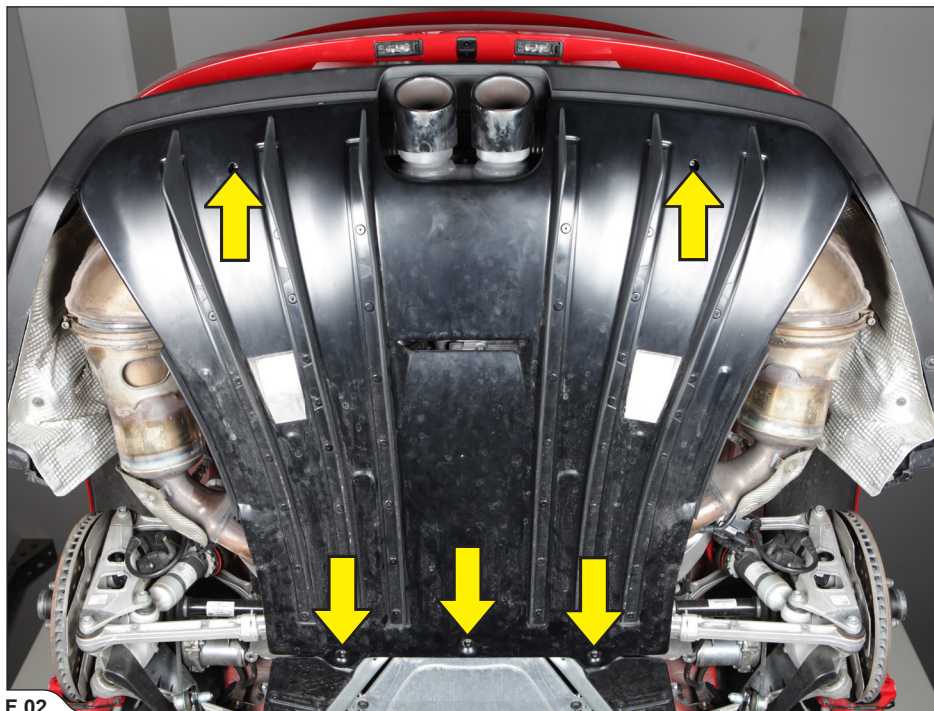

F 02

3. Unscrew the market bolts and nuts on both sides of the vehicle and remove the rear parts of the wheel arches (F 03).

! CAUTION: make sure not to injure yourself or damage any part of the vehicle during this process!

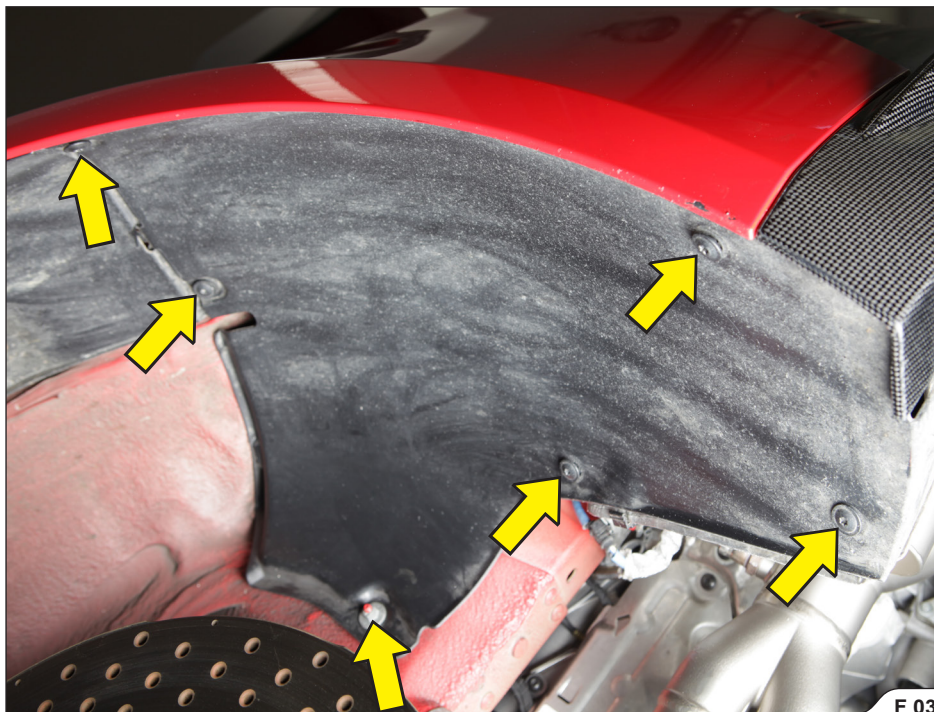

F 03

4. Unscrew the marked bolts on both sides of the vehicle (F 04, 05).

! CAUTION: make sure not to injure yourself or damage any part of the vehicle during this process!

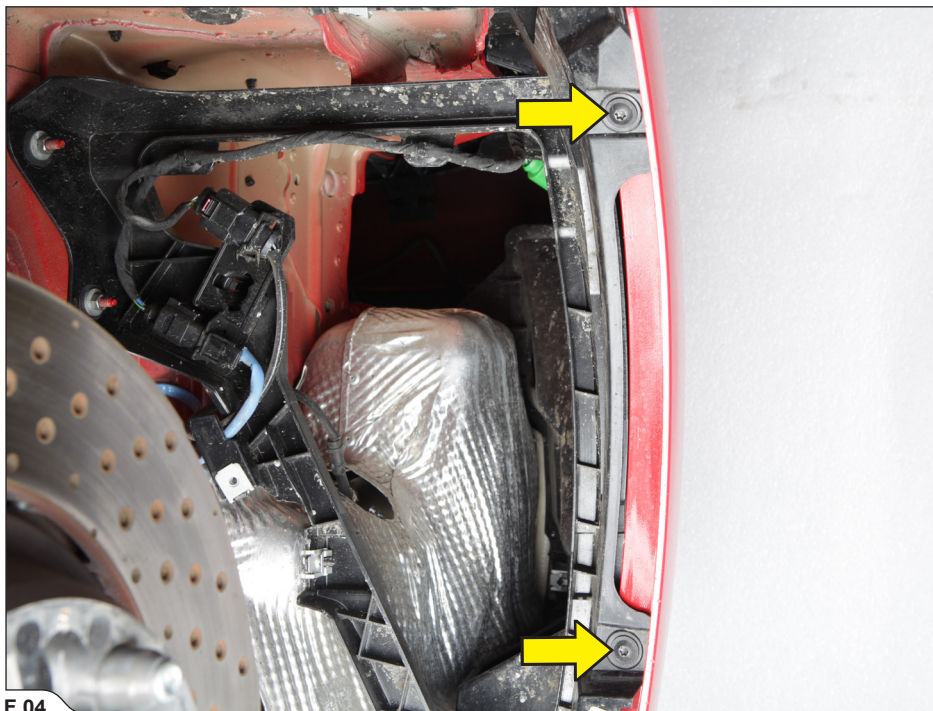

F 04

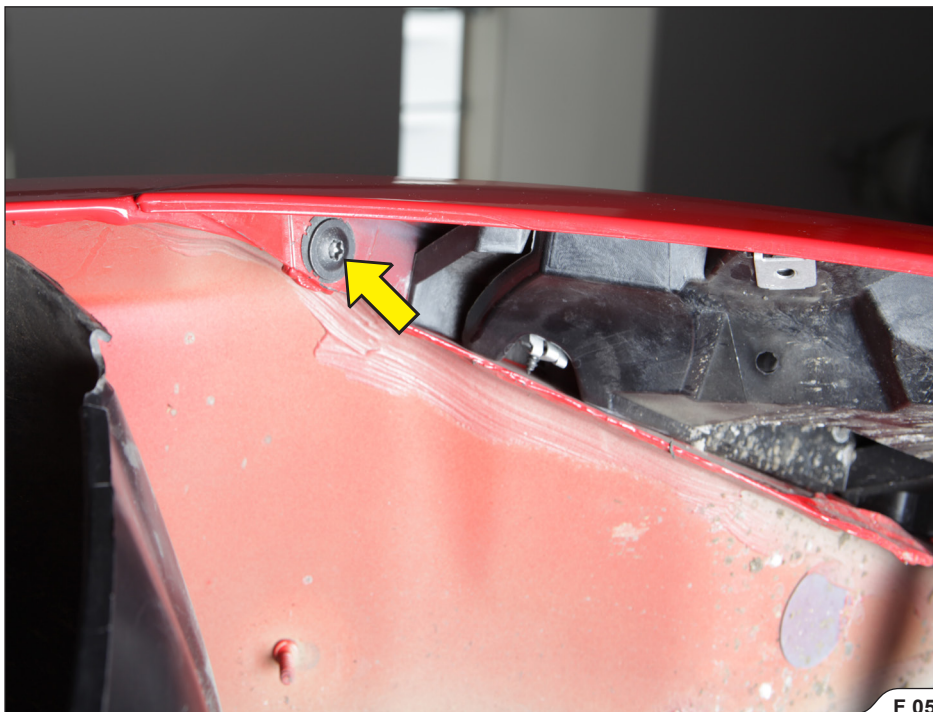

F 05

5. Remove the marked covers; check vehicle workshop manual for correct procedure (F 06).
! CAUTION: make sure not to injure yourself or damage any part of the vehicle during this process!

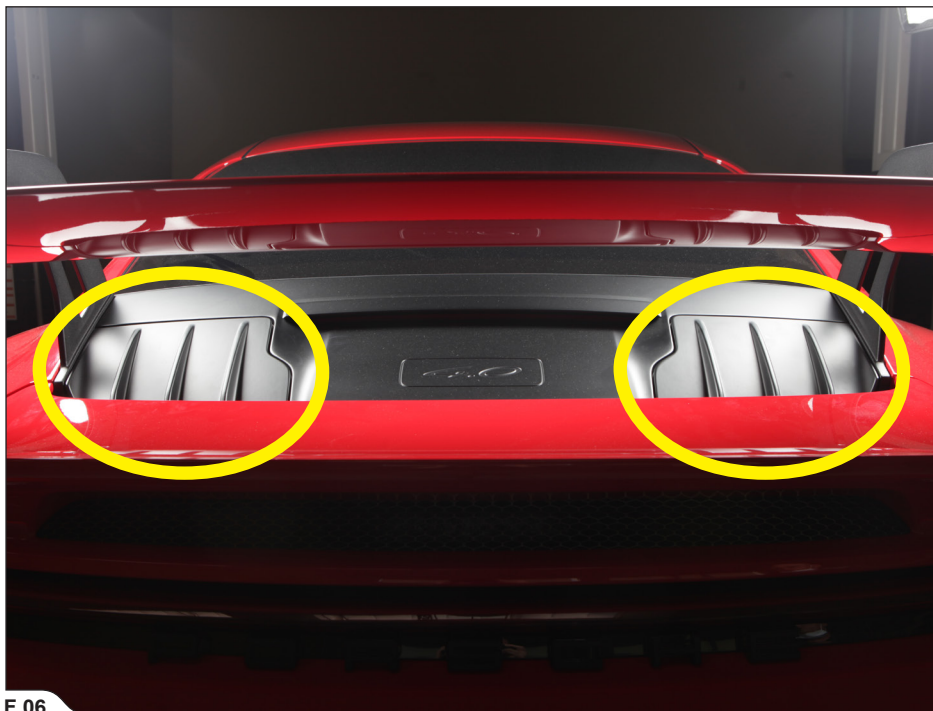

F 06

6. Unscrew the marked bolts (F 07, 08, 09).

! CAUTION: make sure not to injure yourself or damage any part of the vehicle during this process!



F 07

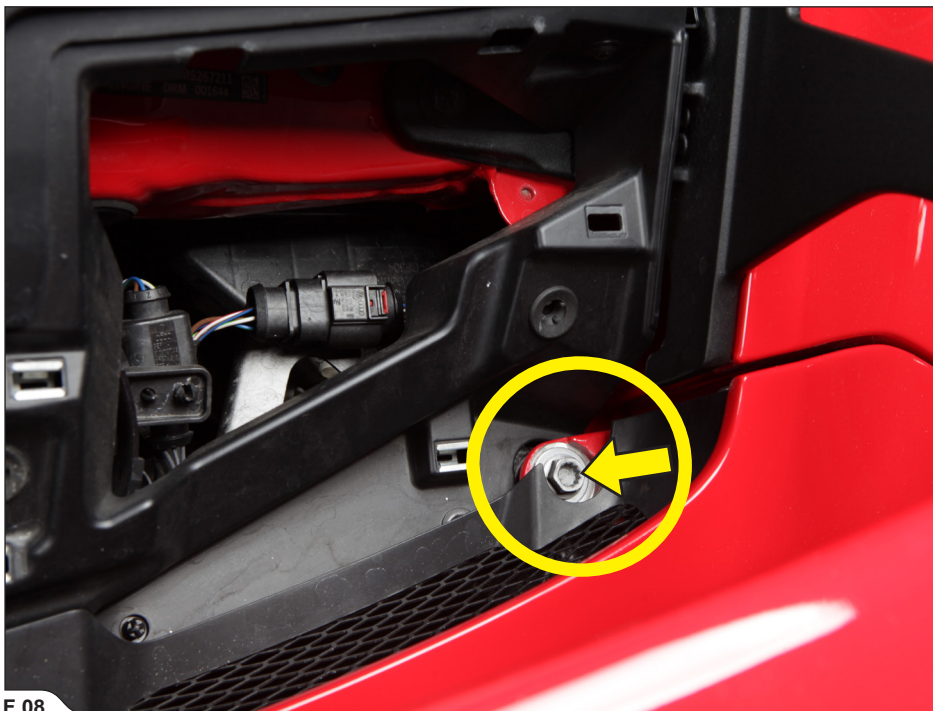

F 08



F 09

- Partially remove the central stop light, undo the marked connectors and carefully remove the stop light off the vehicle (F 10).

! **CAUTION:** make sure not to injure yourself or damage any part of the vehicle during this process!



F 10

8. Unscrew the marked bolts on both sides of the vehicle and carefully pull both tail lights out of the chassis, disconnect the tail lights' electrical connectors and remove the tail lights off the vehicle (F 11, 12).

! CAUTION: make sure not to injure yourself or damage any part of the vehicle during this process!

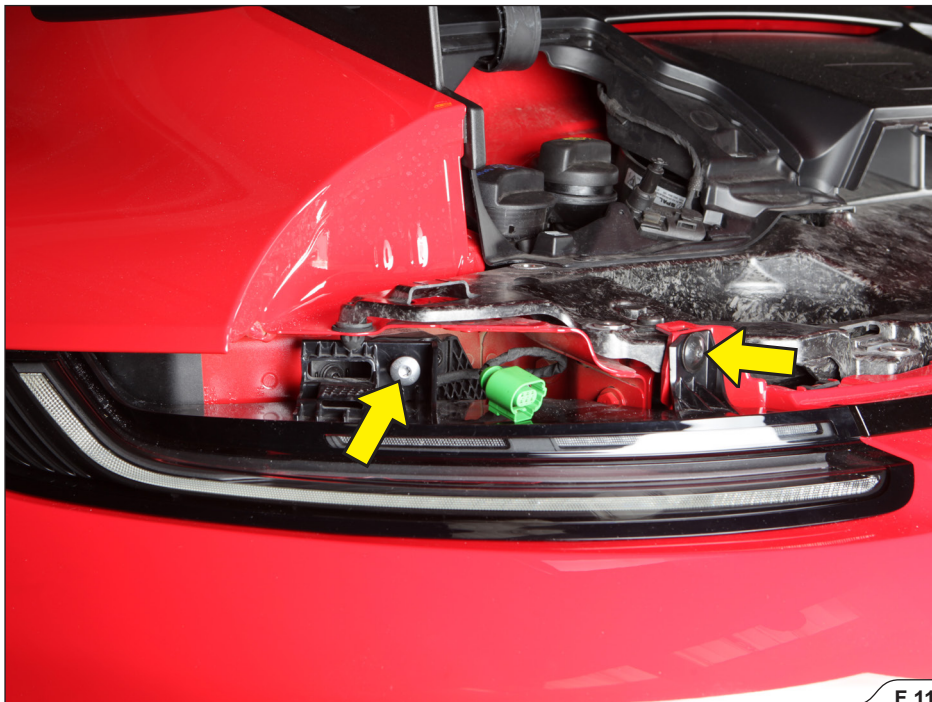

F 11



F 12

9. Unscrew the market bolts (F 13).

! CAUTION: make sure not to injure yourself or damage any part of the vehicle during this process!

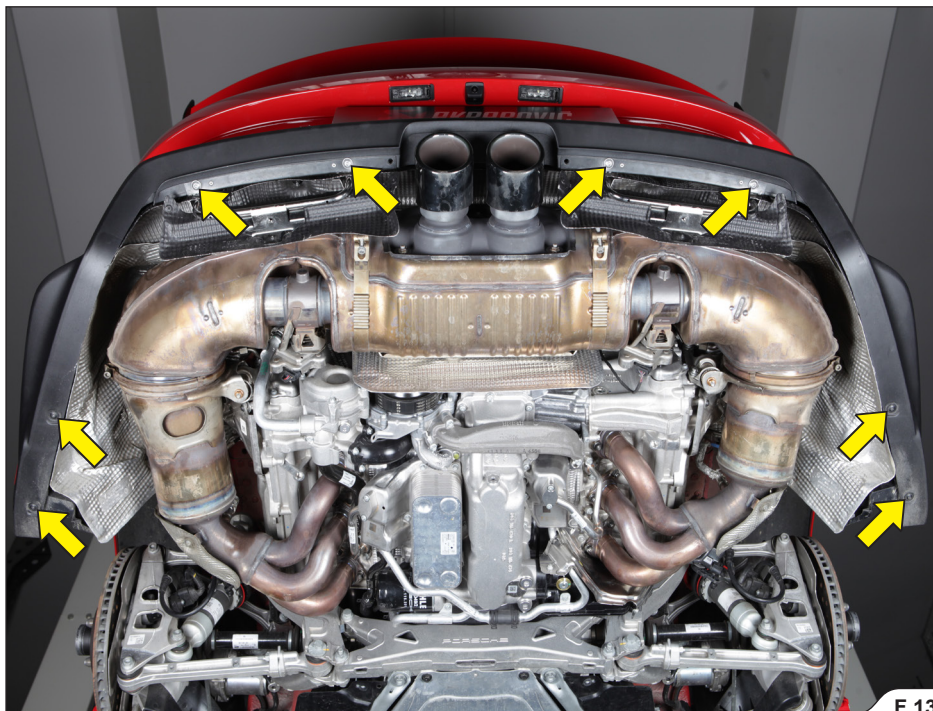

F 13

10. Disconnect the bumpers' electrical connectors (F 14, 15).

! **CAUTION:** make sure, not to damage the connectors, bumper or any other part of the vehicle during this process!

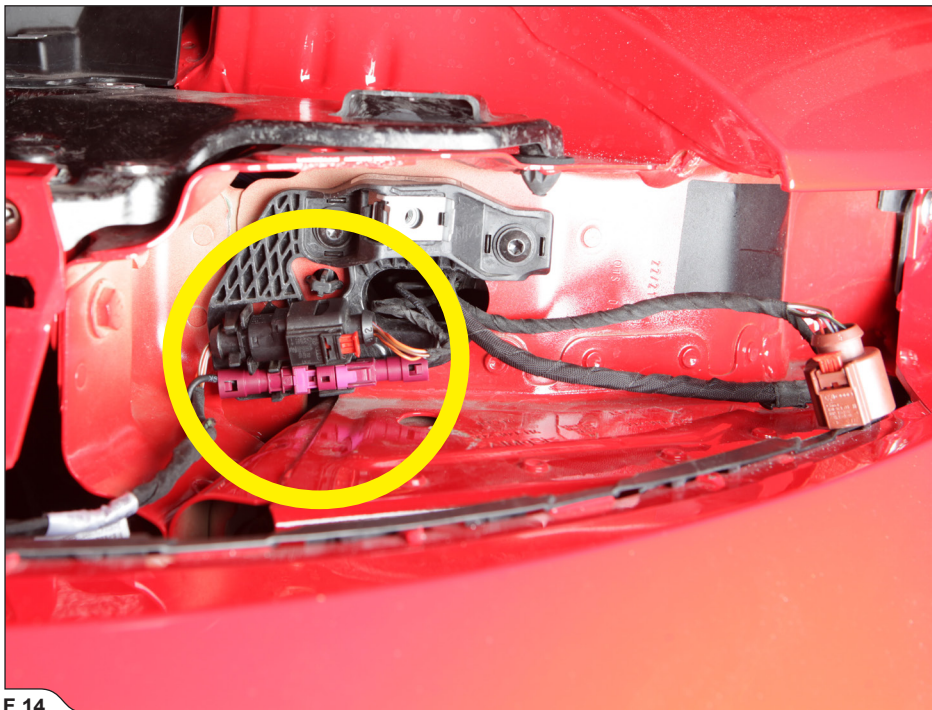

F 14

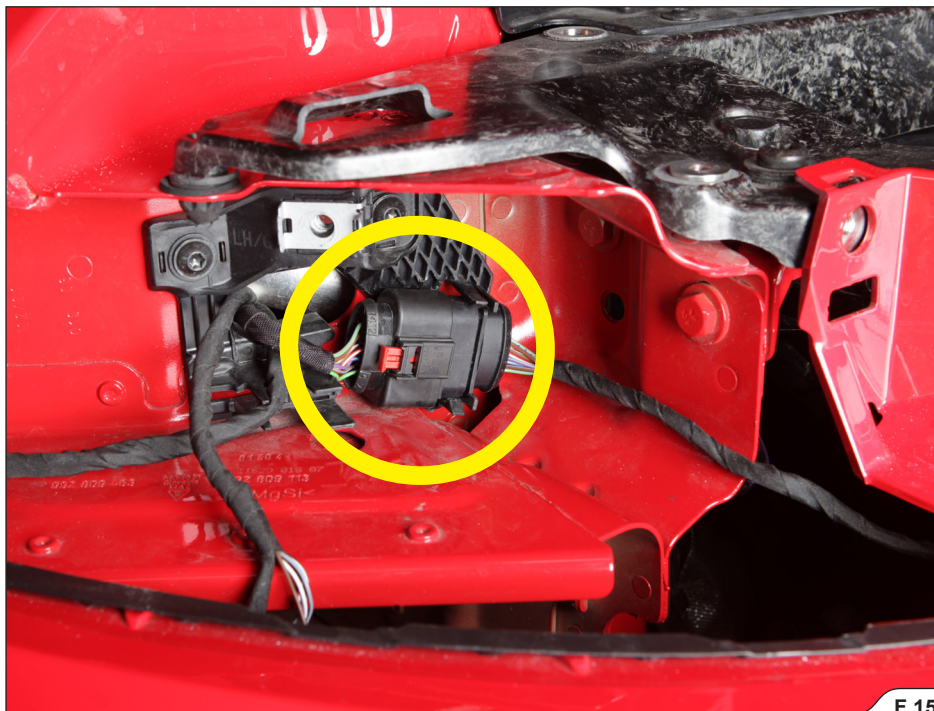

11. Unscrew the marked bolts on both sides of the vehicle, and carefully remove the bumper off the vehicle (F 16, 17).

! **CAUTION:** make sure not to injure yourself or damage any part of the vehicle during this process!



F 16



12. Unscrew the marked bolts on both sides of the vehicle and remove the rear crash bar off the vehicle (F 18, 19).

! CAUTION: make sure not to injure yourself or damage any part of the vehicle during this process!

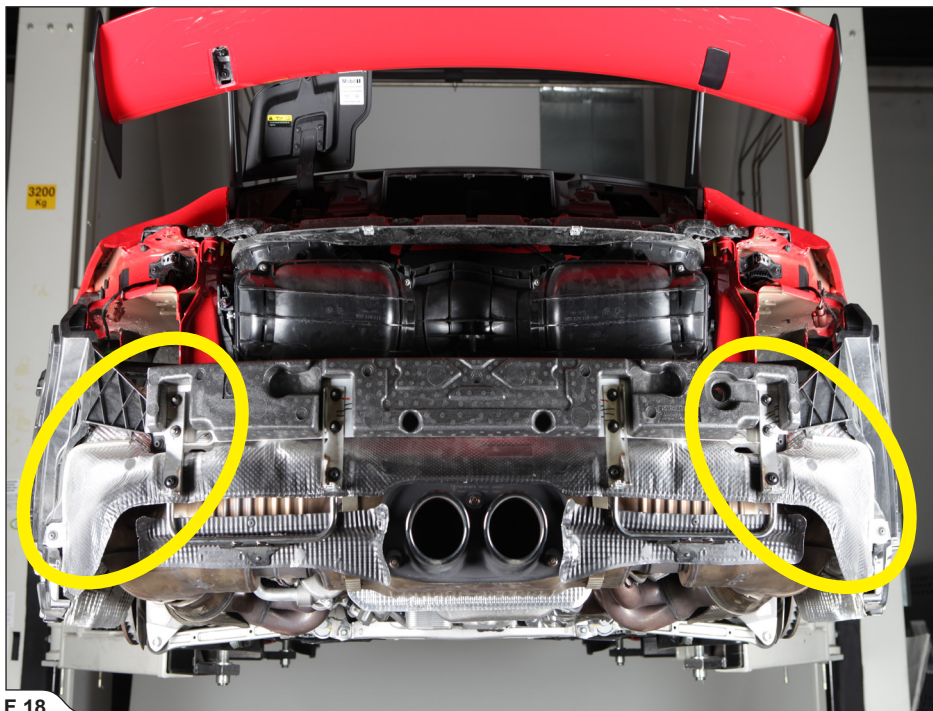

F 18

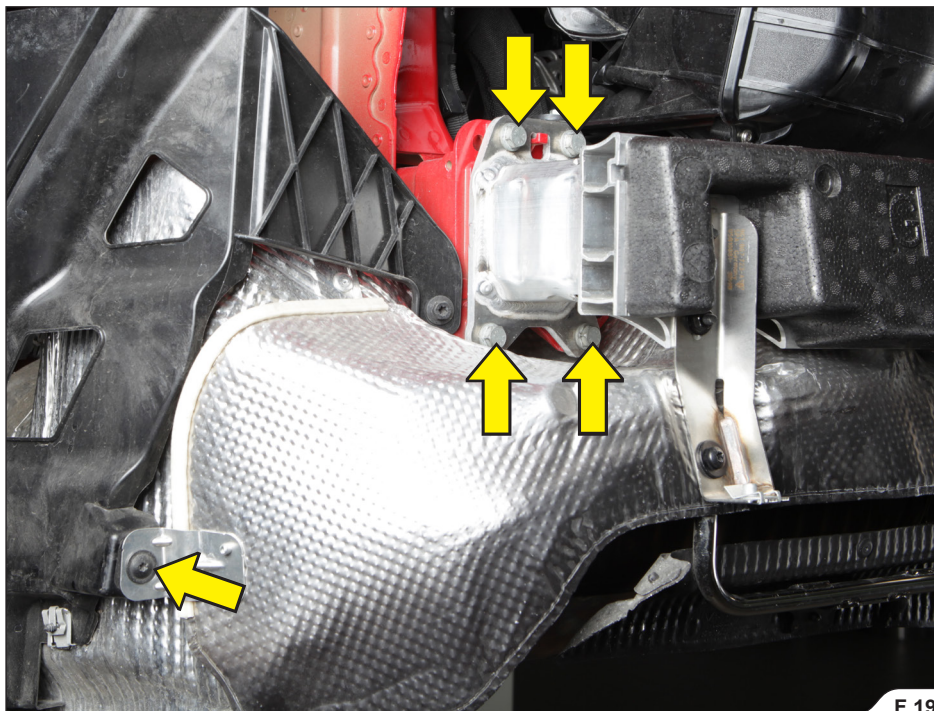

13. Disconnect the exhaust flaps' actuator connectors, unscrew the back-pressure pipes on both sides of the muffler - **for vehicle types with particulate filter only**, unscrew the muffler - headers connecting V-clamps, support the muffler, unscrew and remove the muffler's tape clamps and carefully remove the muffler off the vehicle (F 20, 21, 22, 23, 24).

! **CAUTION:** make sure not to injure yourself or damage any part of the vehicle during this process!

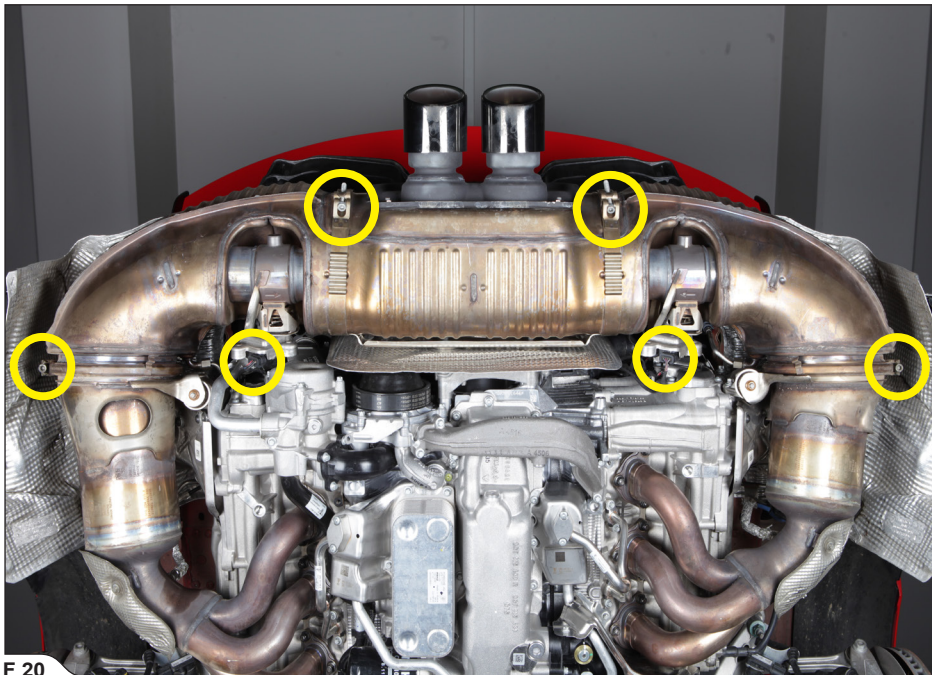

F 20

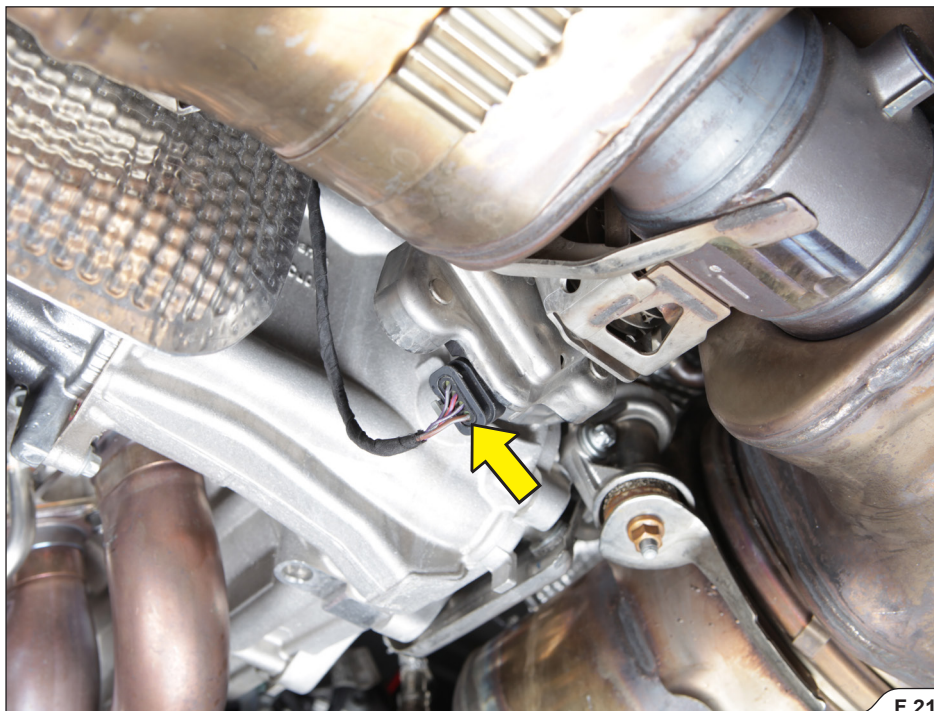

! IMPORTANT: for vehicle types with particulate filter only (F 22)!

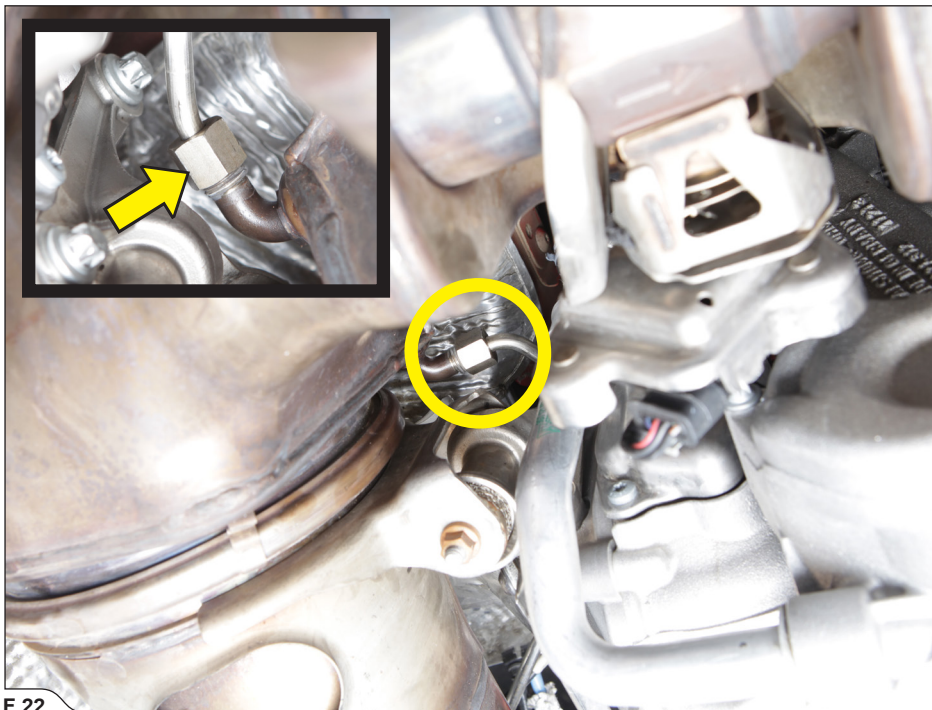

F 22

! IMPORTANT: remove the V-clamps off the joints completely (F 23)!



F 23

! IMPORTANT: support the muffler before removing the tape clamps (F 24)!

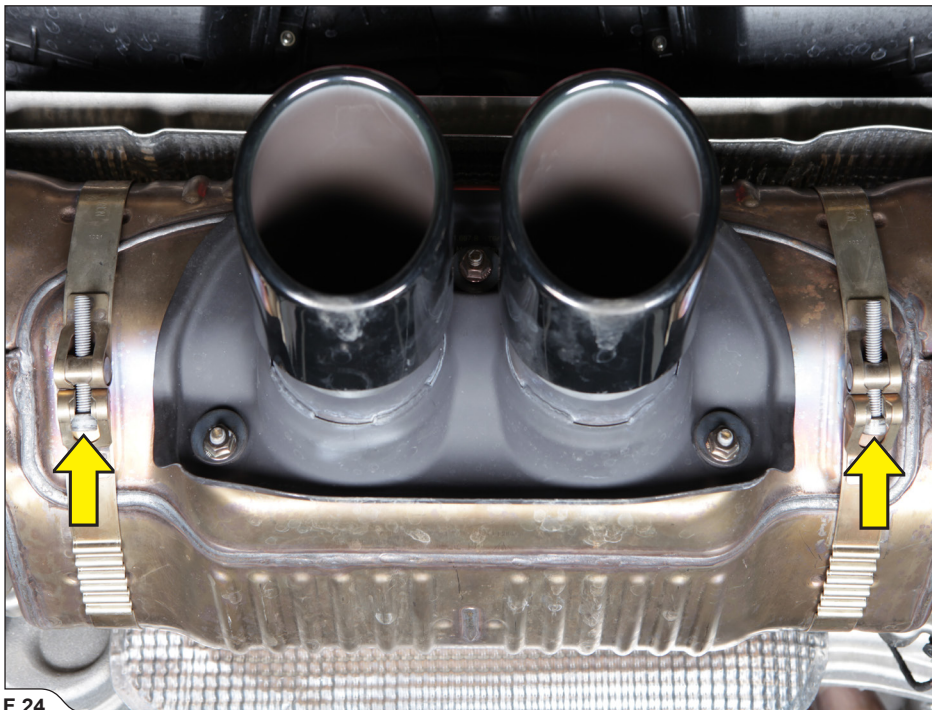

F 24

14. Unscrew and carefully remove both exhaust valve actuators off the muffler (F 25).

! CAUTION: make sure not to injure yourself or damage any part of the muffler during this process!



F 25

INSTALLATION OF THE AKRAPOVIČ EXHAUST SYSTEM:

1. **For vehicle types without particulate filter only:** plug the back-pressure pipes on both Akrapovič Link Pipes, using plug inserts and plug nuts from Akrapovič installation kit (**F 26, 27**).

! CAUTION: make sure not to injure yourself or damage any part of the Link Pipes during this process!



F 26

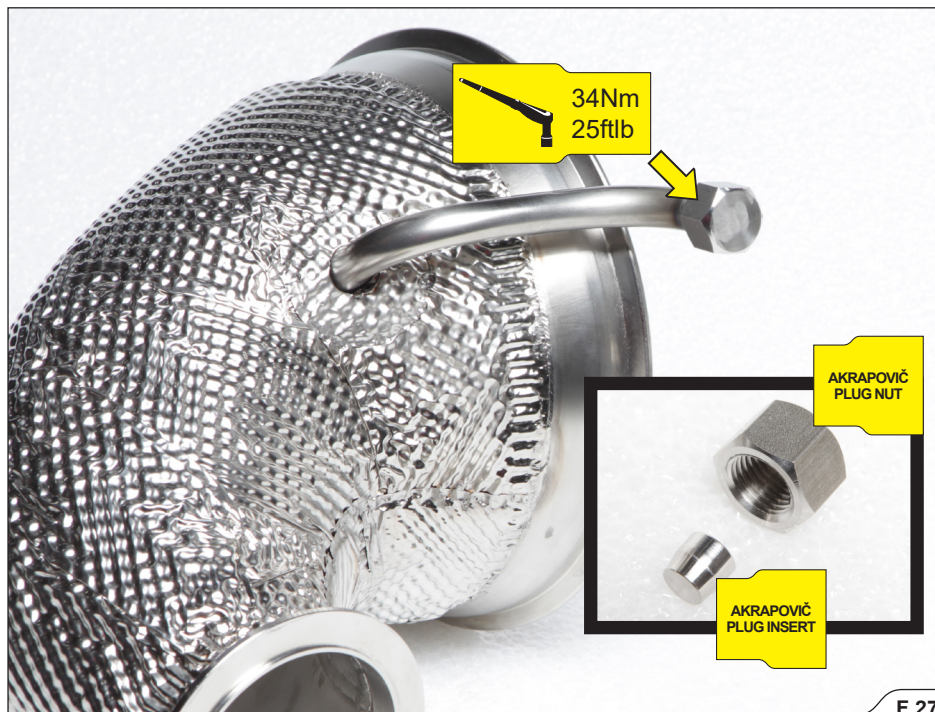

2. Install both Link Pipes onto the headers, using new OEM V-clamps (F 28).

! **CAUTION:** make sure not to injure yourself or damage any part of the vehicle during this process!

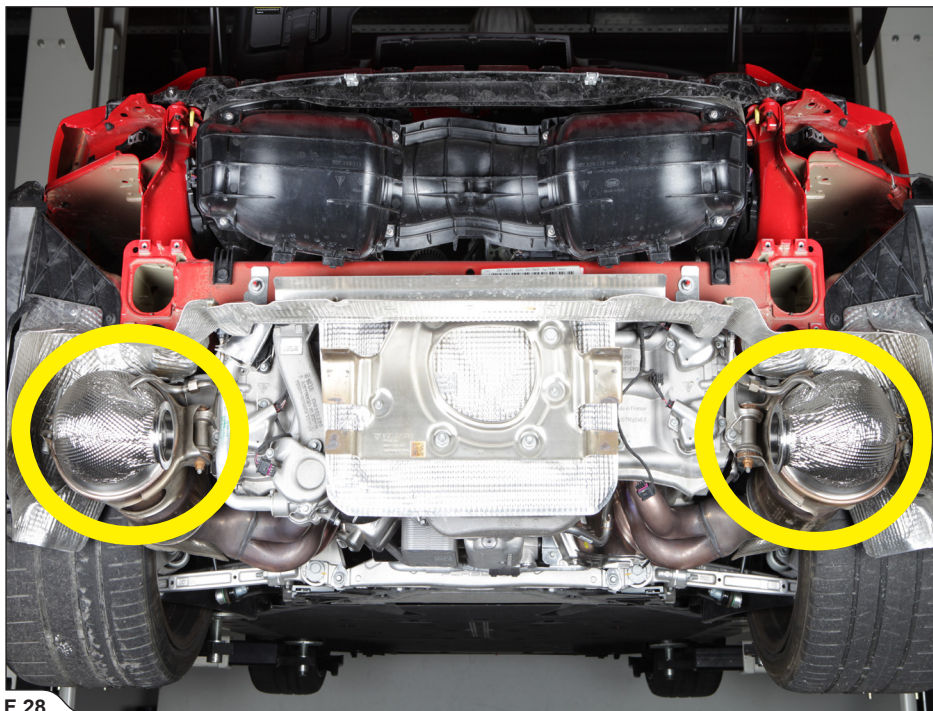

F 28

! IMPORTANT: hand tighten the V-clamps; do not fully tighten them yet (F 29)!

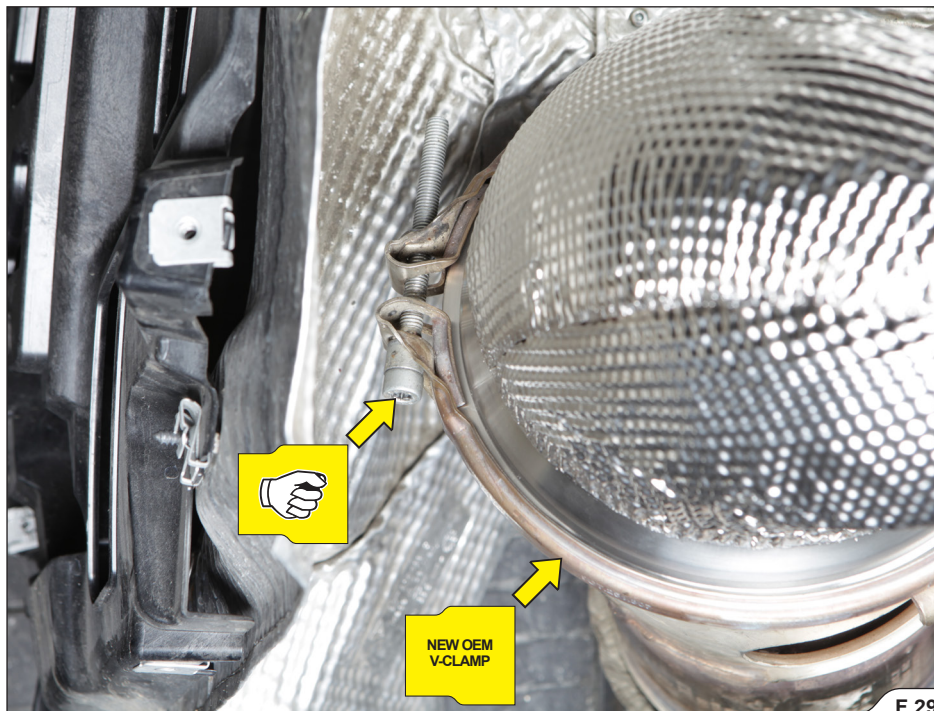

F 29

3. For vehicle types with particulate filter only: connect both back-pressure pipes (F 30).

✂ **INSTALLATION TIP:** for easier installation, loosen the pipes' bracket bolts on the engine block.

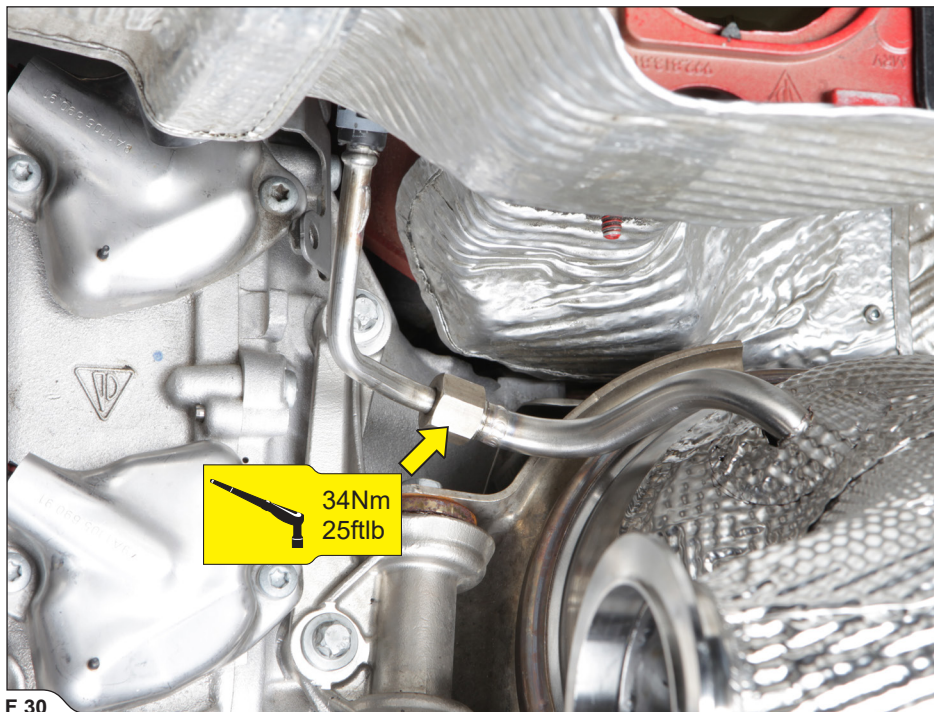

F 30

4. Put the V-clamps from Akrapović installation onto both Link Pipes (F 31).

! **CAUTION:** make sure not to injure yourself or damage any part of the vehicle during this process!



F 31

5. Install the stock exhaust valve actuators onto both Akrapovič valve pipes, using spring connections, heat shields and bolts from Akrapovič installation kit (F 32, 33, 34, 35, 36).

! **IMPORTANT:** make sure not to mix the actuators! Put them on the same valves as they were on stock exhaust system!

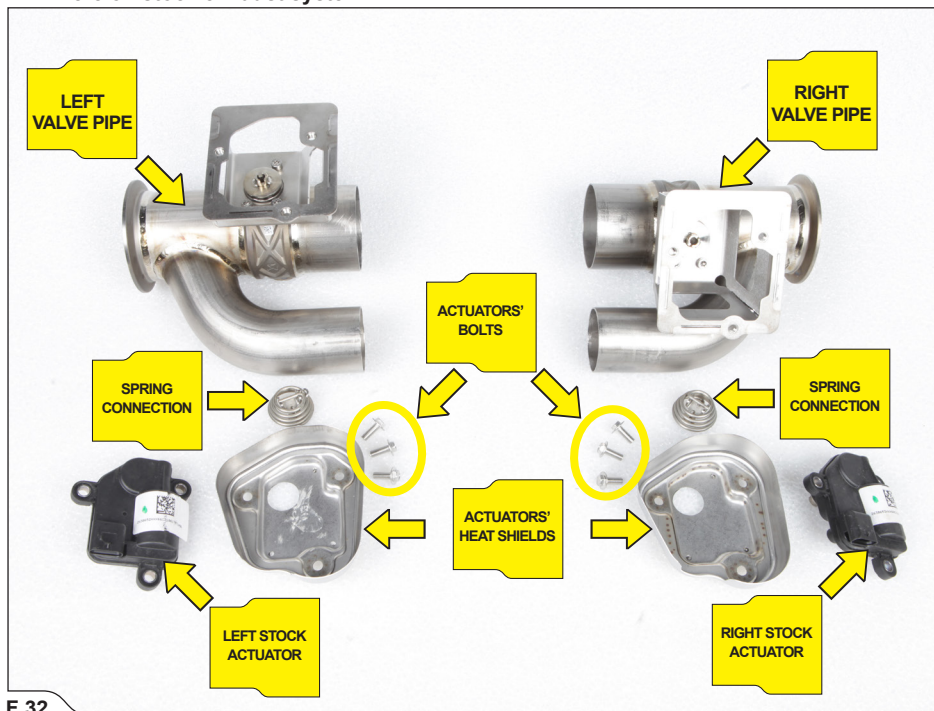

F 32

! **IMPORTANT:** make sure, that spring connection seats correctly into the valves' axle grooves (F 33, 34)!



F 33

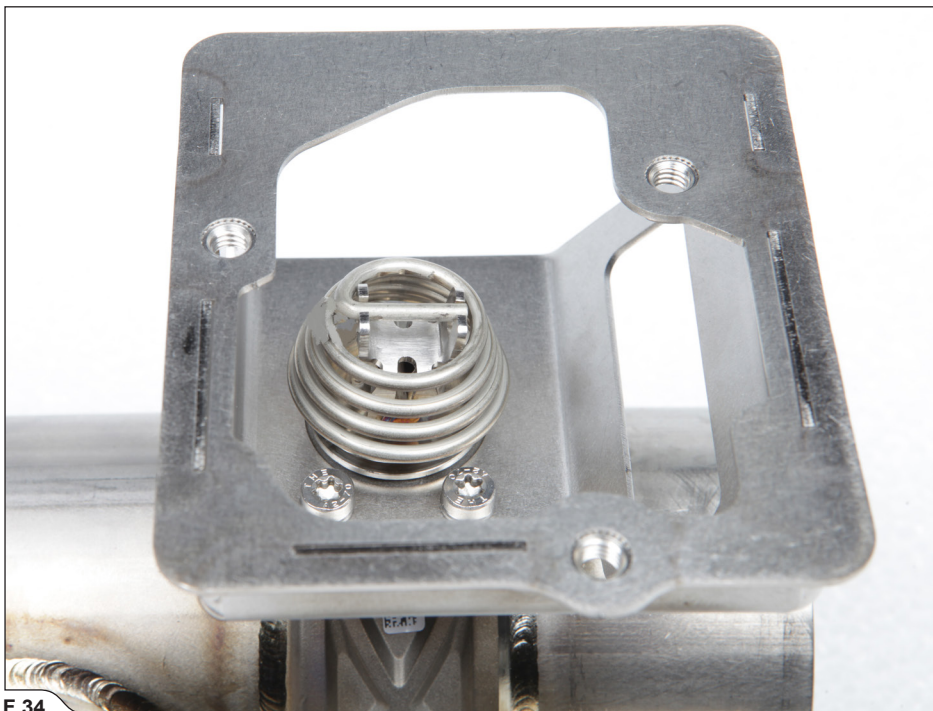

F 34



F 35

- ! **IMPORTANT:** make sure, that actuators' axle grooves seat correctly into spring connections (F 36)!
- ! **IMPORTANT:** use Akrapovič bolt sealant on all bolt threads (F 36)!

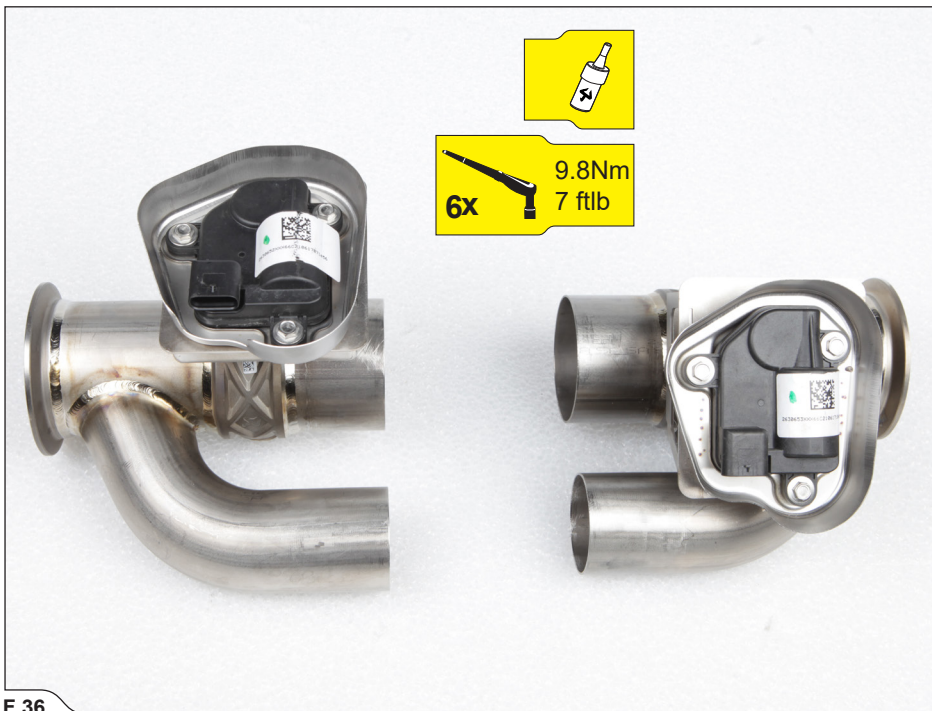

F 36

6. Install the clamps from Akrapovič installation kit onto the muffler, as shown (F 37, 38, 39).

! CAUTION: make sure not to injure yourself or damage any part of the muffler during this process!



F 37

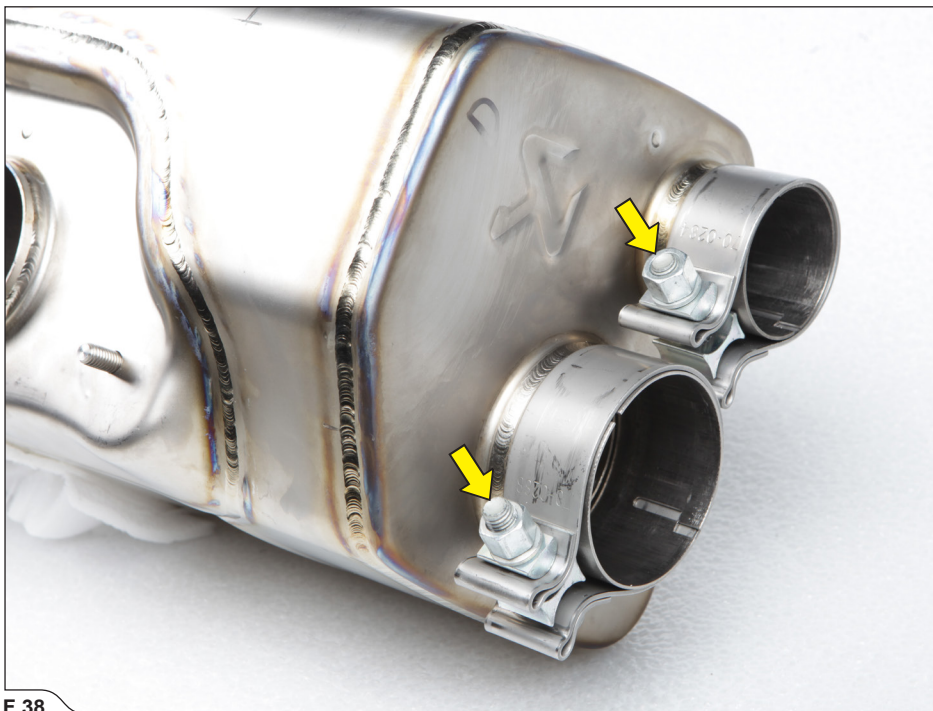

F 38

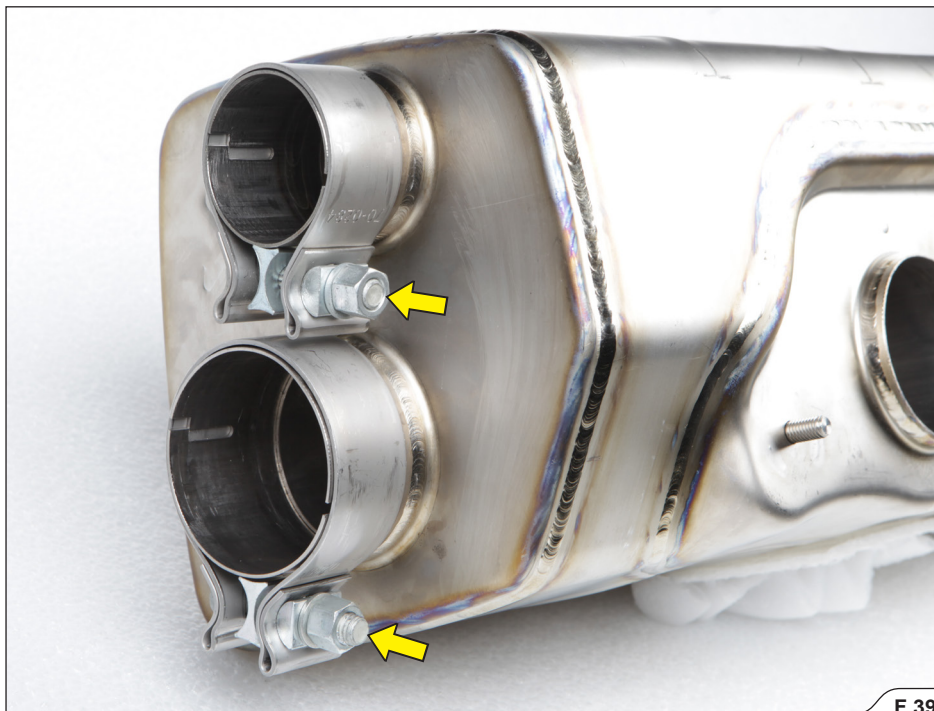

F 39

7. Install the assembled valve pipes onto the muffler, as shown (F 40, 41, 42).

! CAUTION: make sure not to injure yourself or damage any part of the exhaust system during this process!

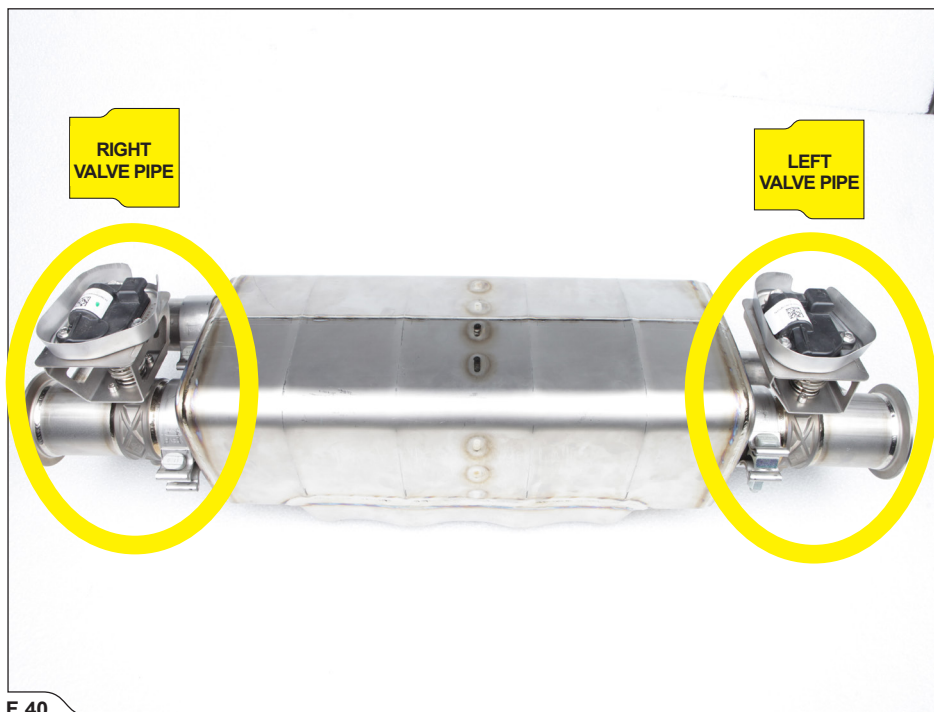

F 40

! IMPORTANT: hand tighten the clamps; do not fully tighten them yet (F 41, 42)!

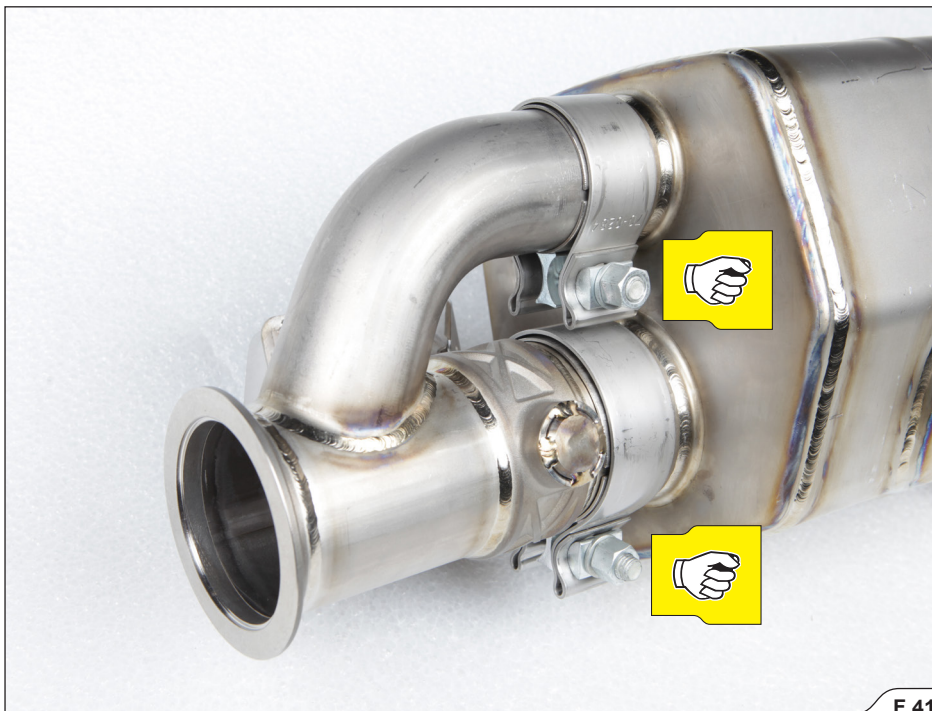

F 41



F 42

8. Install the muffler onto the vehicle; correctly install the V-clamps and hand tighten them only (F 43).

! **CAUTION:** make sure not to injure yourself or damage any part of the vehicle during this process!

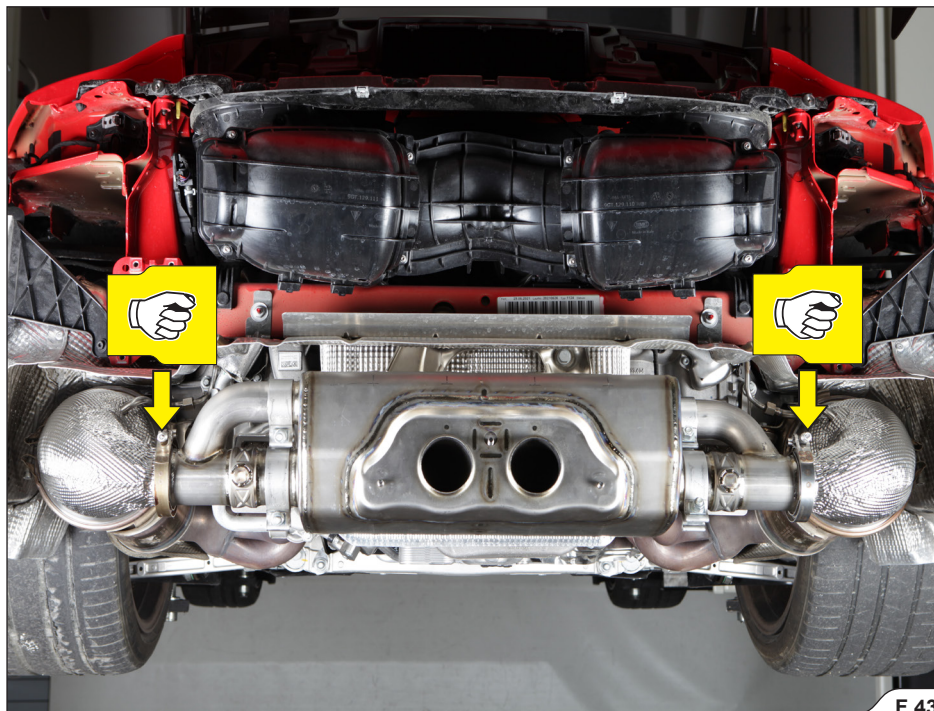

F 43

9. Rotate and center the muffler in respect to the vehicle chassis; make sure, that muffler aligns with stock muffler bracket, then tighten all clamps to the specified torques (F 44, 45, 46, 47).

! **CAUTION:** make sure not to injure yourself or damage any part of the vehicle during this process!

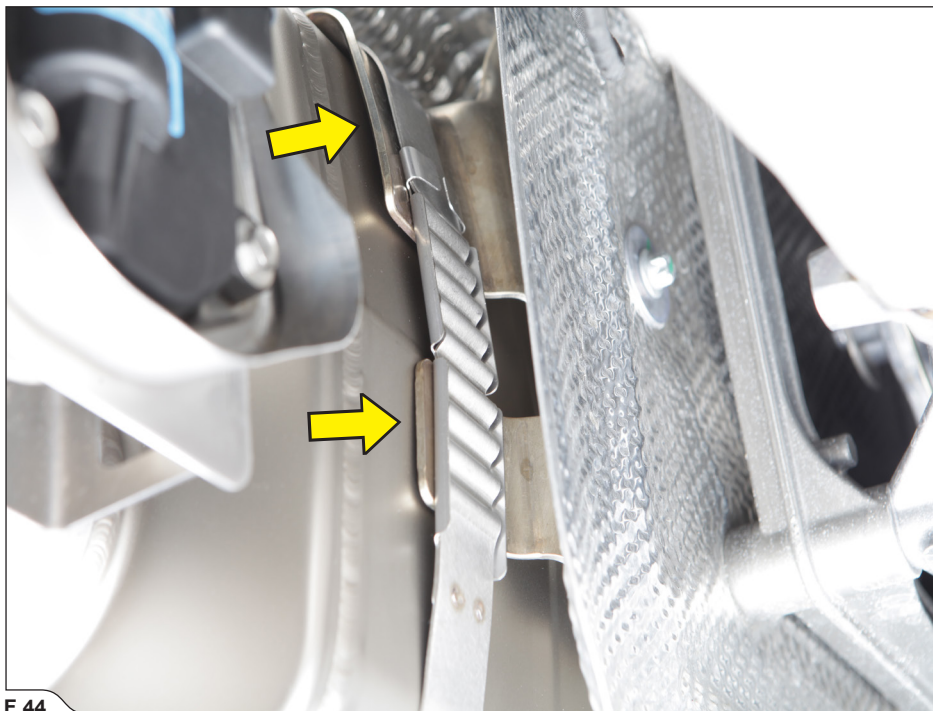

F 44

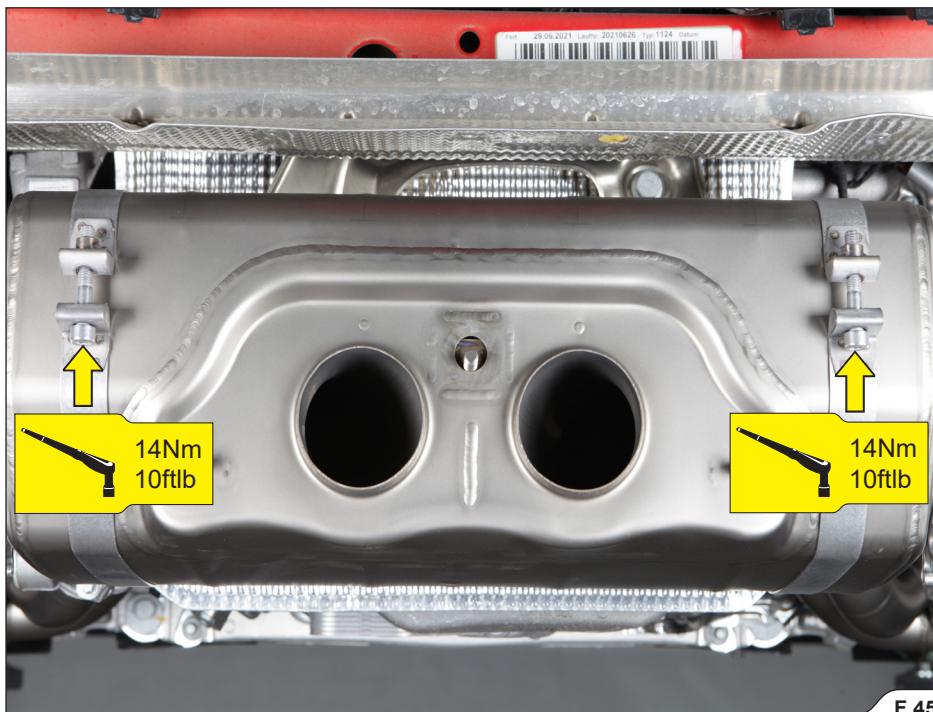

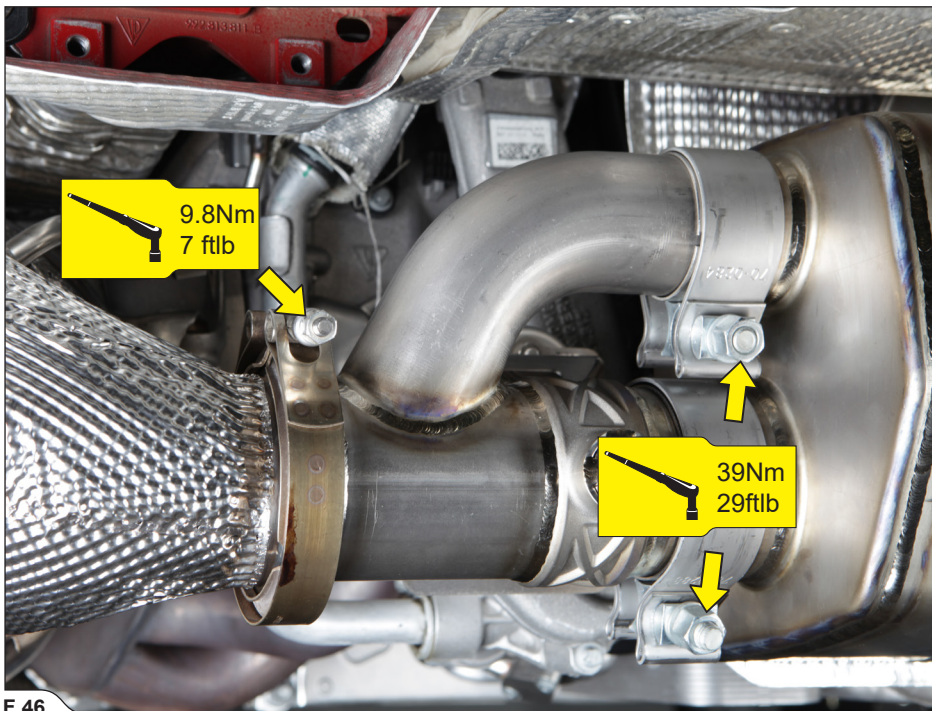

F 46

! IMPORTANT: check vehicle workshop manual for correct tightening torque (F 47)!

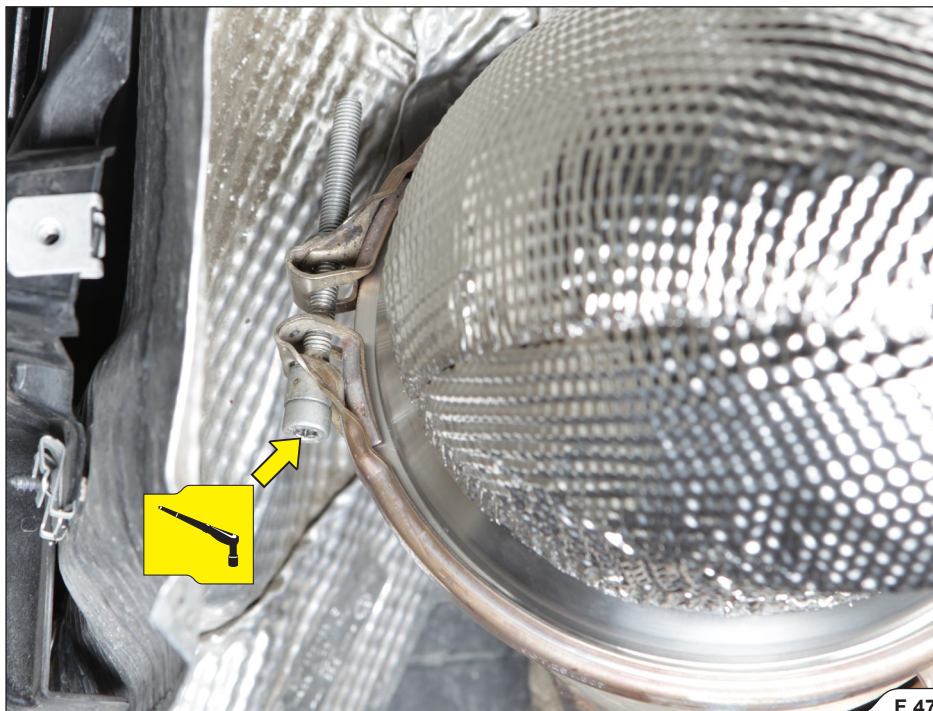

F 47

10. Connect the connectors to the actuators on both sides of the vehicle (F 48).

! CAUTION: make sure not to injure yourself or damage the vehicle or exhaust system during this process!



F 48

11. Reinstall the rear bumper; check vehicle manufacturer workshop manual for correct procedures and tightening torques.

! **CAUTION:** make sure not to injure yourself or damage any part of the vehicle during this process!

12. Install the Tail Pipes onto the muffler, using eccentric washers and nuts from Akrapović installation kit; adjust and center the Tail Pipes and tighten the nuts to the specified torque (F 49).

! **CAUTION:** make sure not to injure yourself or damage any part of the vehicle during this process!

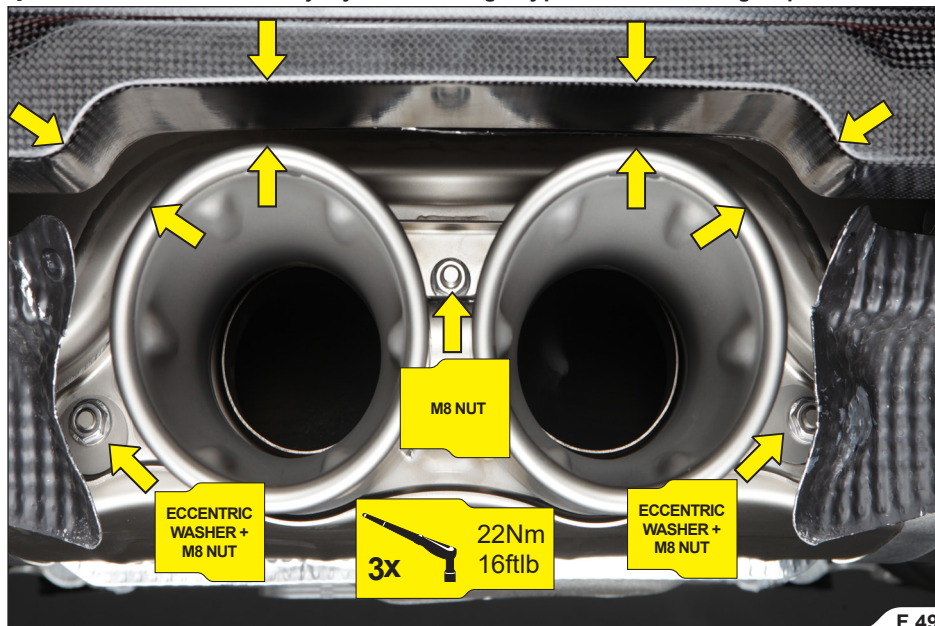

13. Reinstall all dismantled stock parts (rear lights, wheel arches, wheels etc.); check vehicle manufacturer workshop manual for correct procedures and tightening torques (**F 50**).

! **CAUTION:** make sure not to injure yourself or damage any part of the vehicle during this process!



F 50

FINAL INSTALLATION:

- ! **IMPORTANT:** reinstall the dismantled or partially removed stock parts (wheel arches, bumper etc.); check vehicle manufacturer workshop manual for correct procedures and tightening torques.
- ! **IMPORTANT:** make sure all the nuts and bolts are sufficiently tightened. In case the Akrapovič product touches the cowling or other parts, repeat the adjustment of the product or contact your authorized dealer.
- ! **IMPORTANT:** clean all Akrapovič product's surfaces before the first start of the engine or the stains will burn onto the surfaces!

MAINTENANCE OF THE AKRAPOVIČ PRODUCT:

1. Clean all Akrapovič product's surfaces. Cleaning will prevent spots from burning onto the surface. Do not use aggressive chemical cleaners, because they can damage the surface:
 - **Titanium surfaces** (titanium muffler's outer sleeve, titanium pipes etc): use a soft cloth sprayed with a multi-purpose spray lubricant (WD-40® or equivalent)*, then wipe with a soft dry cloth.
 - **Carbon-fiber surfaces** (carbon-fiber outlet cap, carbon-fiber muffler's outer sleeve, carbon-fiber bracket etc): use a soft dry cloth sprayed with all purpose foam cleaner, then wipe with a soft dry cloth.
 - **Painted surfaces** (painted outlet cap, painted muffler's outer sleeve, painted bracket etc): use a soft cloth sprayed with all purpose foam cleaner, then wipe with a soft dry cloth.
 - **Chrome plated surfaces** (chrome plated outlet cap, chrome plated muffler's outer sleeve etc): use a soft cloth sprayed with all purpose foam cleaner, then wipe with a soft dry cloth.
 - **Stainless steel surfaces** (stainless steel muffler's outer sleeve, stainless steel pipes etc): use a soft cloth sprayed with a contact cleaner, then wipe with a soft dry cloth.

*WD-40® is a trademark of the WD-40 Company.
2. Periodically check if all the Akrapovič product's nuts and bolts are sufficiently tightened.

- ! **IMPORTANT: IT IS NORMAL FOR WHITE SMOKE TO COME OUT OF THE MUFFLER AT FIRST OPERATION.**
- ! **CAUTION: DO NOT STAND BEHIND THE MUFFLER AT ANY TIME.**
- ! **IMPORTANT: DO NOT USE AUTOMOTIVE WHEEL CLEANERS OR ANY CLEANING PRODUCTS WHICH CONTAIN ACIDIC ADDITIVES TO CLEAN THE AKRAPOVIČ EXHAUST SYSTEMS.**
- ! **IMPORTANT: WE RECOMMEND HIGH CAUTION WHEN USING POWER / PRESSURE WASHER FOR CLEANING PAINTED / LACQUERED SURFACES OF THE AKRAPOVIČ COMPONENTS, TO AVOID PAINT / LACQUER DAMAGE.**
- ! **IMPORTANT: SOME OF THE AKRAPOVIČ CARBON FIBER COMPONENTS ARE ADDITIONALLY PROTECTED AGAINST ROCK CHIPS WITH CLEAR LACQUER PROTECTION FILM. THE PROTECTION FILM IS AVAILABLE AS SPARE PART BY AKRAPOVIČ COMPANY. THE PROTECTION FILM IS NOT THE SUBJECT OF THE AKRAPOVIČ WARRANTY.**
- ! **IMPORTANT: ALL AKRAPOVIČ PRODUCTS ARE DEVELOPED AND DESIGNED TO BE USED ON SPECIFIC VEHICLES, FOR THEIR ENTIRE EXPECTED LIFETIME. PLEASE MAKE SURE THAT END-OF-LIFE AKRAPOVIČ PRODUCT IS DISASSEMBLED TO COMPONENTS SHOWN IN THE PRODUCT'S SCHEMATIC DIAGRAM AVAILABLE ON THE AKRAPOVIČ WEBSITE AND EACH COMPONENT SCRAPPED RESPONSIBLY AND ACCORDING TO APPLICABLE LOCAL LAWS AND REGULATIONS. AKRAPOVIČ DOES NOT ASSUME ANY OBLIGATION OR RESPONSIBILITY WITH RESPECT TO THE SCRAPPING PROCESS OR PROVIDING INFORMATION RELATED THERETO.**
- ! **CAUTION: THE EXHAUST SYSTEM CAN BE EXTREMELY HOT. ALLOW THE EXHAUST AND ENGINE TO COOL DOWN BEFORE BEGINNING INSTALLATION OR ANY OTHER WORK ON THE EXHAUST SYSTEM. THIS MANUAL IS SPECIFIC TO THE PORSCHE 911 GT3 TYPE 992. THERE MAY BE SOME DIFFERENCES IN INSTALLATION PROCEDURES FOR OTHER MODELS.**

TROUBLESHOOTING:

Problem	Possible cause	Solution
Exhaust gas leaks out of the muffler/ pipe clamp connections	loosened clamp	tighten the clamp to specified torque
	connection is not completely joined	tap the connection into place and tighten the clamp to specified torque

[EMPTY PAGE]

[EMPTY PAGE]

[EMPTY PAGE]

www.akrapovic.com

